

Características Técnicas

Caudal máximo: 60 l/h

Conexión rosca: 3/4"

Conexión maguera: Diámetro 6x12

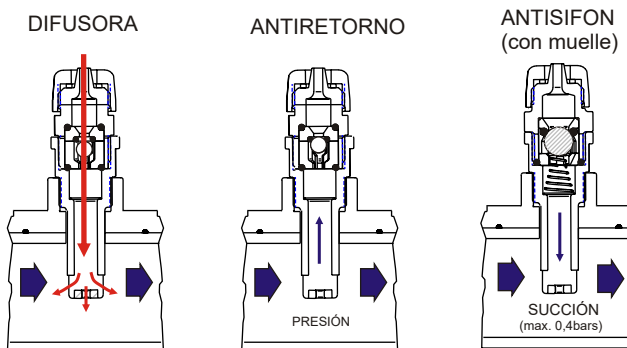
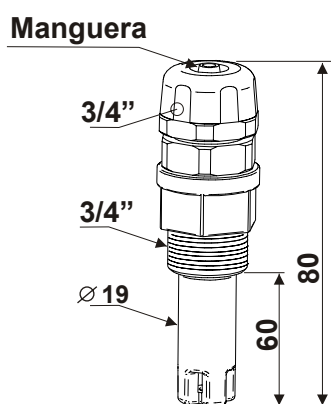
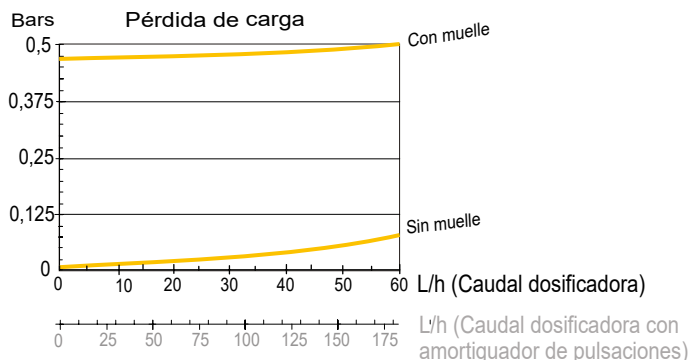

VÁLVULAS DE INYECCIÓN 6x12

Polipropileno
18-822-P

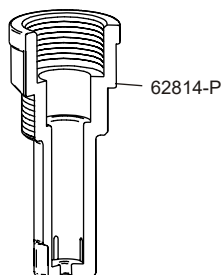
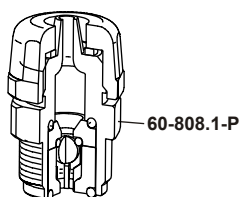

PVDF
18-822-F
18-821-F (6x8)

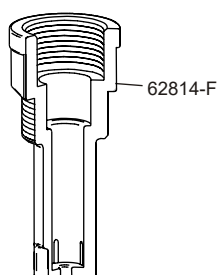
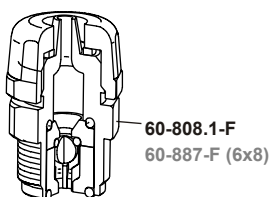

AISI 316
18-822-I

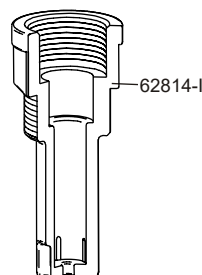
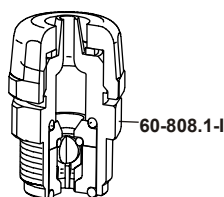

Polypropylene with spring
18-823-P (Spring SS316)
18-824-P (Spring HALAR®)

