

### VÁLVULAS DE INYECCIÓN L

#### Características técnicas

Caudal máximo: 60 l/h

Conexión rosca: 3/4"

Conexión collarín: 1/2"

Conexión manguera: 10x12  
(Øint x Øext mm)

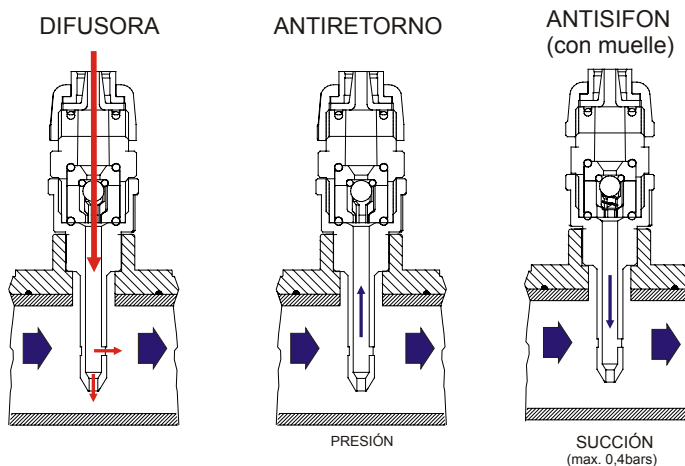
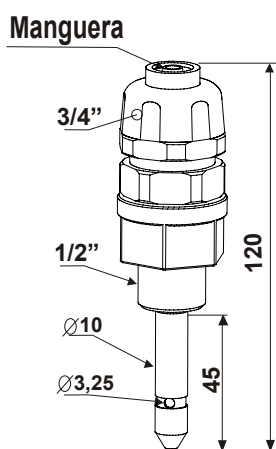
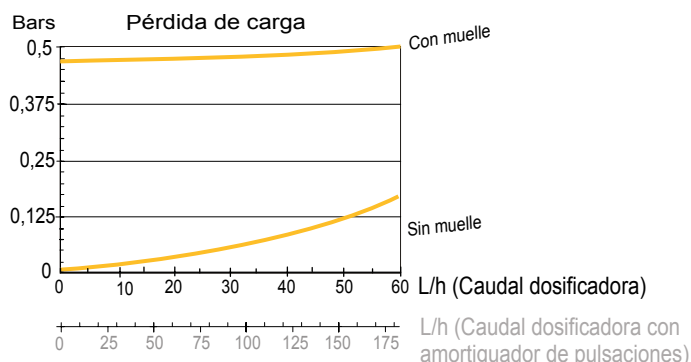

#### DESPIECE

Polipropileno  
18-882-P

PVDF  
18-882-F

AISI 316  
18-882-I

Polipropileno con muelle  
18-883-P

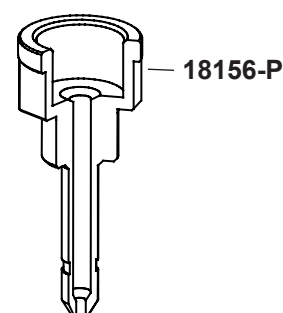
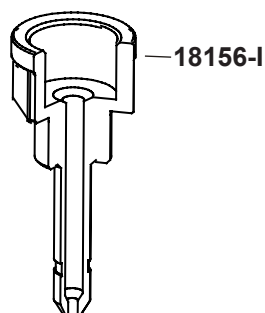
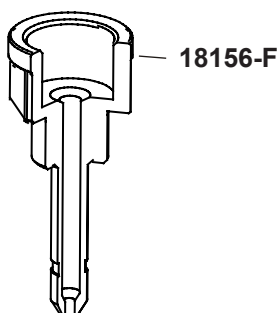
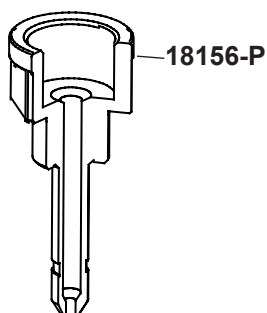
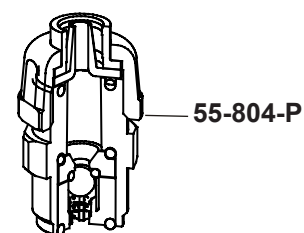
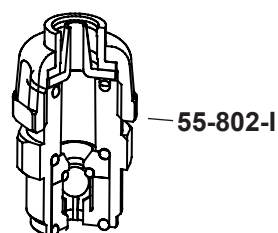
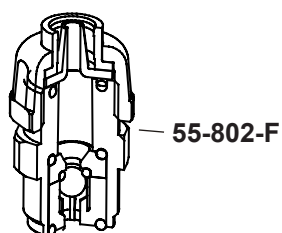
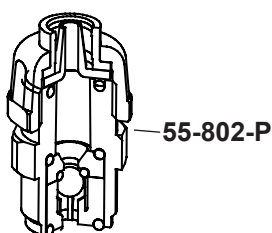

### CONEXIONADO VÁLVULA

Caudal máx.	60 l/h
Manguera	10x12
Bridas	 60877.1-P
Espigas	 55829-P

