



Management System
ISO 9001:2015



www.itc.com
ID: 9186017965

ITC

DOSING PUMPS

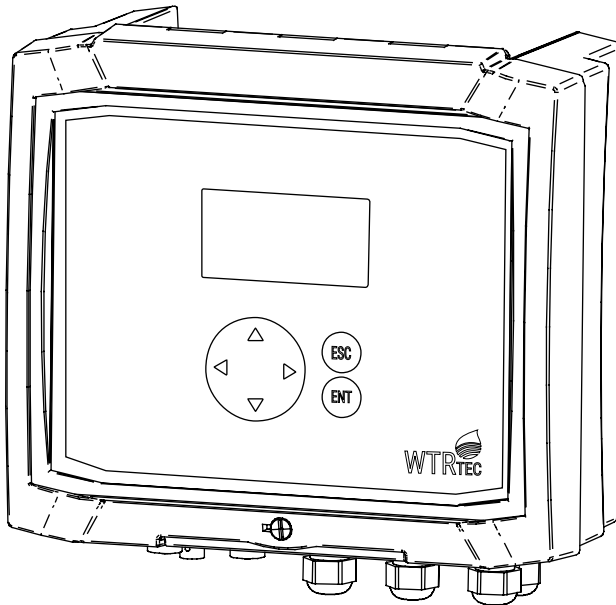

WTRTEC

BLUE **WHITE**

ENGLISH

CONTENTS

1. GENERAL DESCRIPTION	4
2. TRANSPORT AND HANDLING	5
3. TECHNICAL SPECIFICATIONS	6
4. OPERATION	7
4.1 Main screen and navigation	7
4.2 Setpoint configuration	8
4.3 Calibration	8
4.3.1 Chlorine sensor calibration	8
4.3.2 pH calibration	9
4.3.2 RedOx (ORP) calibration	9
4.3.3 Flow rate calibration	9
4.4 Control configuration	10
4.4.1 Activation of the control channels	10
4.4.2 Advanced control configuration for WTRTEC Blue .	11
4.4.3 Advanced control configuration for WTRTEC White .	12
4.5 Alarms	14
4.5.1 Chlorine, pH and Redox (ORP) alarms	14
4.5.2 Zero flow alarm for WTRTEC Blue .	14
4.5.3 Flow detector alarm	15
4.6 Configuration of the register outputs	15
4.7 Configuration and monitor	16
4.7.1 Initial configuration (SET UP)	16
4.7.2 Communications settings	17
4.7.3 Information on the unit and monitor	17
5. INSTALLATION	18
5.1. Installation diagram	18

5.2. Wiring	19
5.3. Remote start/stop activation	20
6. START UP AND ADJUSTMENT	20
7. MAINTENANCE	21
CE DECLARATION OF CONFORMITY	23
WARRANTY	23



SAFETY INSTRUCTIONS

To avoid personal injury risks and damage to the environment, and to ensure proper equipment operation, personnel responsible for installing, commissioning and maintaining the equipment must follow the instructions in this manual, with special attention to the detailed recommendations and warnings. The specific instructions for the use of the chemicals to be dosed must also be followed.

1. GENERAL DESCRIPTION

WTRTEC Blue and **WTRTEC White** are high-precision free chlorine, pH and RedOx (ORP) controllers that at the same time are simple to install and operate. Specially designed for water purification processes where a level of free chlorine needs to be ensured in the water, either in a tank or in-line.

The **WTRTEC Blue** controller is for regulating the chlorine level in a tank, as well as the pH. In addition to the chlorine and pH reading, it has a RedOx (ORP) reading used as an indirect chlorine measurement reading, so enabling provision of a safety system with redundant information. The controller has two control outputs, analogue (4-20mA) and digital (relay), for the hypochlorite and acid dosing pumps.

It also has a flow meter input to monitor the entry of clean water into the tank. The PIQ internal adjustment system allows for automatic chlorine dosing correction, taking the addition of untreated water received in the tank into account. Chlorine dosing increases proportionally to the water flow filling the tank.

WTRTEC Blue enables monitoring, remote management and historical logging by means of a mobile/web application. A communications Gate (Ref. 01-006) is needed for this, which can be connected to the internet by Ethernet or 3G/4G.

The **WTRTEC White** controller is for regulating chlorine levels in-line in a distribution main, where chlorination needs to be topped up, as well as monitoring and correcting pH. In addition to the chlorine and pH reading, it has a RedOx (ORP) reading used as an indirect chlorine measurement reading, so enabling provision of a safety system with redundant information. The controller has two analogue (4-20mA) control outputs for in-line regulation of the hypochlorite and acid dosing pumps.

It also has a flow meter input to monitor the water flow and, by means of PIQ internal adjustment, to correct the chlorine dosing automatically, adapting it to continuous changes in flow rate.

WTRTEC White enables monitoring, remote management and historical logging by means of a mobile/web application. A communications Gate (Ref. 01-006) is needed for this, which can be connected to the internet by Ethernet or 3G/4G.

INSTALLATION DIAGRAM

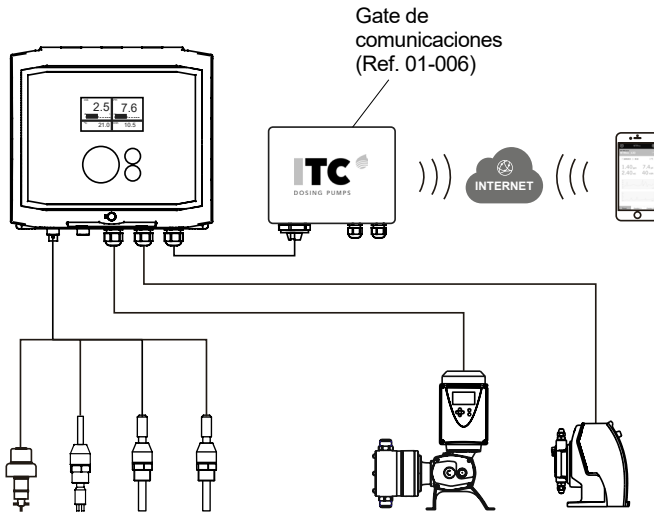

2. TRANSPORT AND HANDLING

The original packaging is designed to allow the equipment to be transported and stored without damage, provided this takes place in dry, ventilated spaces away from heat sources.

Included in the packaging are:

- **WTRTEC**
- Instruction manual

3. TECHNICAL SPECIFICATIONS

Power supply: 100-240 V 50-60 Hz. 10.8-14.4 VDC

Power: 6 W

IP65 protection

Housing material: ABS

Working temperature: 0 - 45 °C / 32 - 113 °F

Maximum relative humidity: 95% without condensation

Inputs

Flow meter	0.00-9999 m3/h / gph	NPN isolated
Flow meter (power supply)		12 VDC (100 mA)
Chlorine	0.00 - 3.00	Isolated
ORP (RedOX) sensor	-2000 - +2000	
pH sensor	0.00 - 14.00	Isolated
pH/EC temperature sensor	0.0 - 100°C / 32.0 - 212 F	PT100
Remote input	ON/OFF	12-24 V AC/DC
Flow detector	ON/OFF	NPN isolated

Outputs

Relay 1	Alarm	N.A. 230 V AC 1 A
Relay 2	Alarm	N.A. 230 V AC 1 A
Relay 3	Alarm	N.A. 230 V AC 1 A
Relay 4	Control	N.A. 230 V AC 1 A
Relay 5	Control	N.A. 230 V AC 1 A
4-20 mA 1	Control or record	max. 520 Ohms
4-20 mA 2	Control or record	max. 520 Ohms

Communications

RS485 port ModBus

Dimensions

	mm	inch
A	229	9.02
B	225	8.86
C	119	4.69

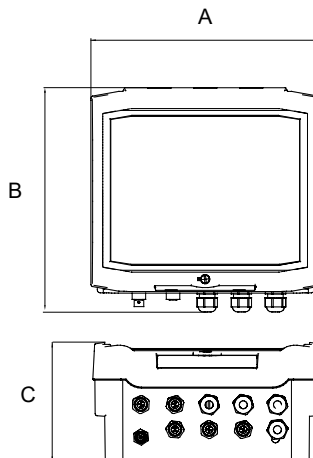

4. OPERATION

4.1 Main screen and navigation

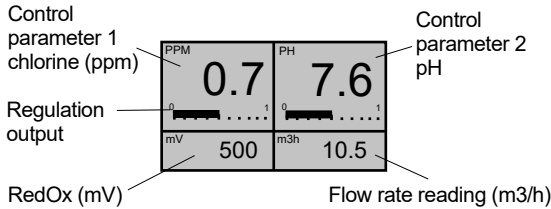

- Confirm
- Exit without confirming
- Increase / decrease value, and move up /down
- Decrease / increase value, and move down /up
- Move left / right
- Move right / left

Warnings on the main screen:

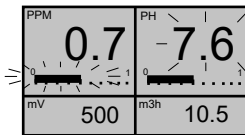

- Flashing reading: parameter alarm
- Flashing regulation output: no device detected on the 4-20 mA output
- Flashing regulation outputs (both): remote control deactivated, or no device connected to the 4-20 mA outputs

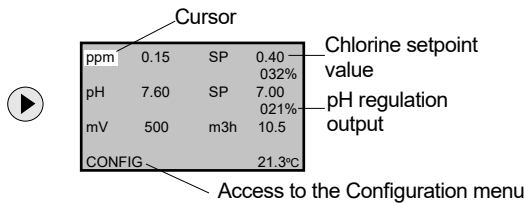

Move the cursor to select the following menu: ppm, pH, mV, m3h or CONFIG, and enter with ENTER

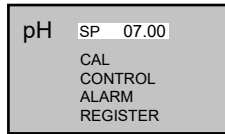
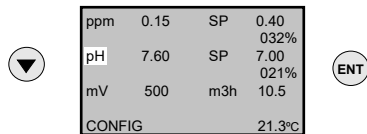

Press ENTER to edit the setpoint or move the cursor to enter the following menu:
 CAL: Calibration
 CONTROL: control output
 ALARM: alarms
 REGISTER: output for register

Calibration menu

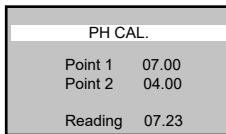

Control menu

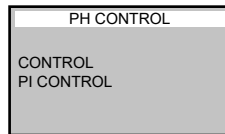

Alarm menu

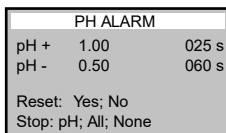

Register menu

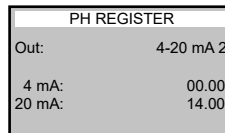

4.2 Setpoint configuration

Setting the desired values for free chlorine (ppm) and pH for the two control channels by values or setpoints, as well as the RedOx (ORP) reference value for alarm.

To enter the setpoint:

ppm	0.15	SP	0.40
			032%
pH	7.60	SP	7.00
			021%
mV	500	m3h	10.5
CONFIG	21.3°C		

ENT

ppm	SP	00.40
CAL	CONTROL	
ALARM	REGISTER	

ENT

change the value with the up/down arrows and confirm with ENT

ppm	0.15	SP	0.40
			032%
pH	7.60	SP	7.00
			021%
mV	500	m3h	10.5
CONFIG	21.3°C		

ENT

pH	SP	07.00
CAL	CONTROL	
ALARM	REGISTER	

ENT

change the value with the up/down arrows and confirm with ENT

ppm	0.15	SP	0.40
			032%
pH	7.60	SP	7.00
			021%
mV	500	m3h	10.5
CONFIG	21.3°C		

ENT

mV	SP	0500
CAL	ALARM	
ALARM	REGISTER	

ENT

change the value with the up/down arrows and confirm with ENTER

4.3 Calibration

Calibration of the sensors used for chlorine, pH, RedOx and flow. The calibration menu is in each parameter menu.

4.3.1 Chlorine sensor calibration

ppm	SP	00.40
CAL	CONTROL	
ALARM	REGISTER	

ENT

CL CAL.
1 POINT
2 POINTS
CLEANING

ENT

CL CAL. 1 POINT	
Point 1	01.53 ppm
Reading	00.50 ppm

One point calibration is the most appropriate in the majority of cases. Only in the case of extremely low chlorine setpoint values will it be more appropriate to use two point calibration, allowing for calibration of the 0.00 ppm point.

For one point calibration, take a sample of water in contact with the sensor and measure the level of free chlorine by means of a DPD test. Correct the ppm value on the screen with the up/down arrows to adjust to the DPD value and confirm with ENTER.

Periodically the controller activates an electrochemical cleaning process of the ITC chlorine sensor electrodes.

The default parameters are best suited for most installations. In the cleaning menu, apart from enabling/disabling cleaning, you can set the cleaning frequency as well as the duration of the cleaning.

In case the defaults are not satisfactory, contact the ITC technical support to rate changing the settings.

CL CLEANING	
Run:	ON
Frequency:	8 h
Time:	60 s



Do not make any parameter changes without consulting first with the ITC Technical support. The default parameters are best suited for most installations.

4.3.2 pH calibration

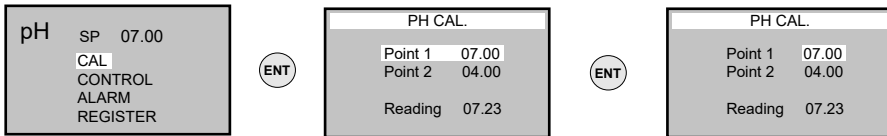

If necessary for pH calibration point 1, modify the buffer value using the up/down arrows. Insert the sensor into the point 1 buffer, wait until the sensor reading is stable and confirm with ENTER.

Repeat the operation with the point 2 buffer. Before putting the sensor in the point 2 buffer, clean the sensor with distilled water and dry it well (with tissue paper) to avoid contamination of the buffer. If at any time during the calibration process you are not sure of the calibration, you can exit without confirming by pressing ESCAPE.

4.3.2 RedOx (ORP) calibration

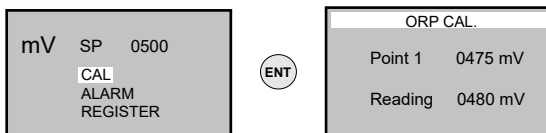

If necessary for mV calibration point 1, modify the buffer value using the up/down arrows. Insert the sensor into the point 1 buffer, wait until the sensor reading is stable and confirm with ENTER.

If you are not sure of the calibration, you can exit at any time during the calibration process without confirming by pressing ESCAPE.

4.3.3 Flow rate calibration

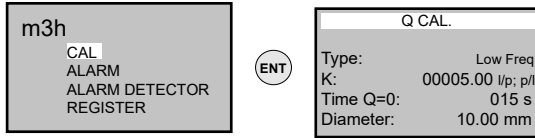

Select the type of flow meter:

- Low Freq:

Low frequency flow meter. Flow meters with pulse frequencies of between a minimum of 1 pulse every 200 seconds and a maximum of 30 pulses per second (30 Hz).

- K (l/p):

This type of flow meter requires entry of the configuration value the manufacturer indicates in litres/pulse.

- Time Q=0:

In these flow meters, which calculate the flow rate from the time between two consecutive pulses, a wait time from which the flow rate is considered to be zero needs to be defined.

- High Freq:

High frequency flow meter for Hall effect or electromagnetic insertion flow meters with a maximum of 300 Hz (300 pulses per second).

- K-factor (p/l):

This type of flow meter requires entry of the K-factor (pulses/litre), corresponding to the diameter where it is installed. This value is supplied by the manufacturer.

- Pump:

Enter the rated dosing pump flow rate to record the dosed flow rate in the data logger.

4.4 Control configuration

4.4.1 Activation of the control channels

Activate control in the two parameters chosen for the regulation.

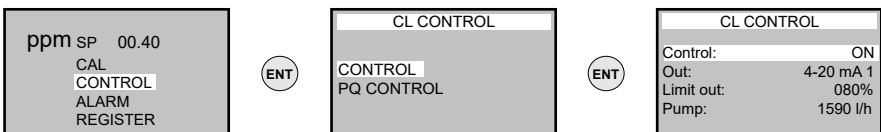

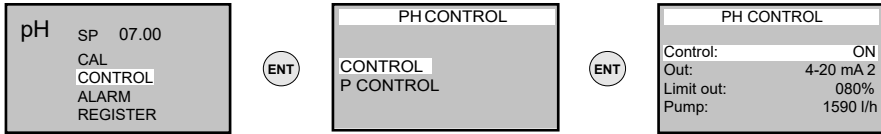

- Free chlorine control:

Dosing will be regulated automatically to adjust the free chlorine reading to the value entered as the setpoint value in ppm.

- Control in pH:

Dosing will be regulated automatically to adjust the pH reading to the value entered as the pH setpoint.

The regulating output will need to be selected for each control channel:

- Out:

Choose between the two 4-20 mA channels for analogue regulation or between the relay outputs for ON/OFF regulation.

Out = 4-20 mA. For in-line process control. This is more precise regulation, which requires a pump with a 4-20 mA analogue input, such as a Dositec mA, Dostec AC or Dostec with variable frequency drive.

Out = Relay. For control in a recirculating tank. The regulating output establishes 5-minute cycles in which the output will be ON for the proportional part of the time corresponding to the regulating output.

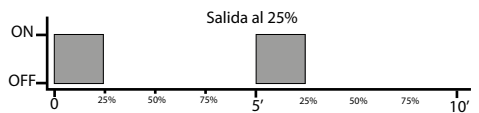
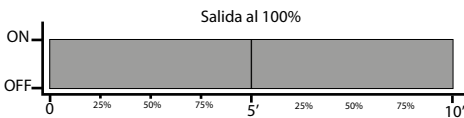

- Limit out:

If a 4-20 mA output is used, this parameter allows you to limit the output value so as to limit the maximum dosing pump flow rate.

4.4.2 Advanced control configuration for WTR_{TEC} Blue.

Adjustment of the free chlorine and pH control is performed using proportional adjustment P to the difference between the reading and the setpoint. The setting parameters for this control are in the PI CONTROL menu: PQ CONTROL (free chlorine) and P CONTROL (pH).

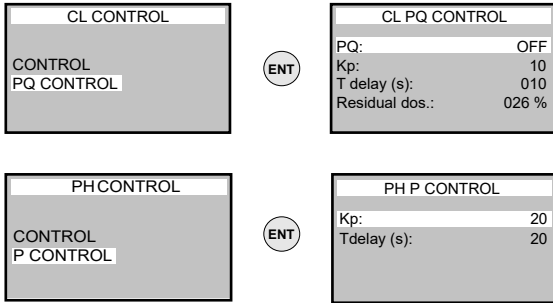

- Kp:

Proportional constant for the control. This parameter enables adjustment of the amount of device response based on the difference between the reading and the setpoint (Error). A value that is too high can produce a reaction that is too abrupt for the system and exceed the setpoint value in the tank, leading to a risk situation. A value that is too low will produce a slow approach to the setpoint.

- T delay (seconds):

T delay is the time between two consecutive controller orders to position the regulating output. For in-tank regulation, it is appropriate for this value to be the minimum.

- PQ Control:

Allows automatic adjustment of chlorine dosing depending on the flow rate of water entering the tank.

- Residual dosing (%):

Enables residual dosing to be set up (in % of regulating output), which will be maintained while chlorine is at the setpoint.

4.4.3 Advanced control configuration for WTRtec White.

Adjustment of the free chlorine and pH control is performed using PI adjustment. The setting parameters for this control are in the PI CONTROL menu

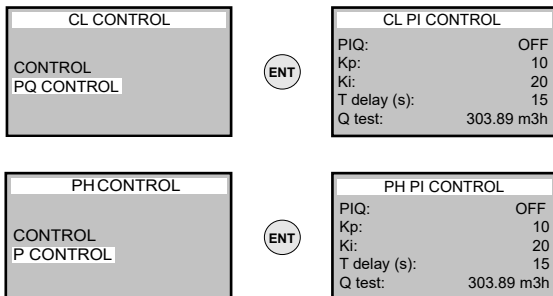

- PIQ:

The PIQ control mode for regulating free chlorine and pH is a PI adjustment algorithm conditional on the flow of water to be treated. When activating the control with the PIQ mode selected, the controller makes a calculation based on the PI setting and uses the instantaneous water flow rate as a reference. For subsequent calculations, the controller will adjust the regulation outputs of the dosing pumps based on the variation between the instantaneous water flow rate with respect to the reference flow rate.

- Kp:

Proportional constant for PI adjustment. This parameter enables adjustment of the amount of device response based on the difference between the reading and the setpoint (Error). The default value is normally correct for the majority of in-line controls. A value that is too high will produce reading oscillations around the setpoint value. A value that is too low will produce a slow approach to the setpoint.

- Ki:

Integral PI adjustment. This parameter acts on the accumulated error and enables reading stabilisation once the setpoint value has been achieved. It is only valid for in-line controls. For recirculating controls it must be $K_i=0$.

- T delay (seconds):

T delay is the time between two consecutive controller orders to position the regulating output. For a proper regulation, this time has to be greater than it takes from a drop of dosed product to travel from the injection point to the point where the pH or free chlorine sensor is located.

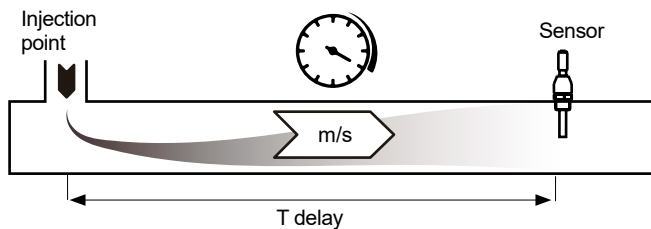

- Q test:

Reference flow rate for T delay that allows for automatic adjustment of T delay with changes in water flow rate, so that T delay is always at an optimal value. To keep T delay fixed, leave $Q_{test} = 0$.

Example: In a 8" pipe through which water passes at 100 m³/h, the water speed is approximately 1 m/s. If the distance between the injection point and the sensor is 10 metres, the installation delay time is 10 seconds.

The sensor will have a reaction time (approximately 10 seconds for the pH sensor), which must be added to the installation delay time. Therefore, a T delay = 20 seconds should be set.

Bear in mind that if there are any filters between the injection point and the sensor, the calculation of 10 metres x 1m/s = 10 seconds will no longer be valid.

4.5 Alarms

4.5.1 Chlorine, pH and Redox (ORP) alarms

To set the alarms, enter the upper and lower tolerance values with respect to the value entered as the setpoint and the time from which, with the reading outside tolerance range, the alarm must be activated. If the value = 0, the alarm is disabled. The alarms will activate only if the Control is ON.

ppm	SP	00.40
	CAL	
	CONTROL	
	ALARM	
	REGISTER	

(ENT)

CL ALARM		
ppm +	1.00	025 s
ppm -	0.50	060 s
Reset: Yes		
Stop: Chlorine		

ppm + 1.00: the alarm is activated when the reading is 1.00 ppm above the setpoint value for 25 seconds
 ppm - 0.5: the alarm is activated when the reading is 0.50 ppm below the setpoint for 60 seconds

pH	SP	07.00
	CAL	
	CONTROL	
	ALARM	
	REGISTER	

(ENT)

PH ALARM		
pH +	1.00	025 s
pH -	0.50	060 s
Reset: Yes		
Stop: pH		

pH + 1.00: the alarm is activated when the reading is 1.00 above the setpoint value for 25 seconds
 pH - 0.5: the alarm is activated when the reading is 0.50 below the setpoint for 60 seconds

mV	SP	0500
	CAL	
	ALARM	
	REGISTER	

(ENT)

ORP ALARM		
mV +	100	025 s
mV -	200	060 s
Reset: Yes; No		
Stop: Chlorine; All; None		

mV + 100: the alarm is activated when the reading is 100 mV above the setpoint value for 25 seconds
 mV - 200: the alarm is activated when the reading is 200 mV below the setpoint for 60 seconds

Reset: enables automatic alarm reset when the reading is back within the permissible values.

Stop: enables shutting down of the dosing control output for the alarmed control parameter, for all or none.

4.5.2 Zero flow alarm for WTRtec White.

An alarm can be set to warn that there is no flow in the main pipe.

If the value = 0, the alarm is disabled.

m3h		
	CAL	
	ALARM	
	ALARM DETECTOR	
	REGISTER	

(ENT)

Q ALARM	
Q = 0	120 s
Reset: Yes	
Stop: All	

Reset: enables automatic alarm reset when the reading is back within the permissible values.

Stop: enables the dosing control outputs to be shut down.

4.5.3 Flow detector alarm

When an external sensor holder is used through which a water sample is made to pass, and this has a flow detector, an alarm can be configured to warn in the event that no water sample reaches the external sensor holder.

If the value = 0, the alarm is disabled.



Reset: enables automatic alarm reset when the reading is back within the permissible values.

Stop: enables the dosing control outputs to be shut down.

4.6 Configuration of the register outputs

If any of the 4-20 mA analogue control outputs is unused, these can be used to be configured as outputs for logging any sensor readings.

To do this, the output to be used needs to be selected and the 4 mA value related to the minimum sensor reading, and the 20 mA value with the maximum reading.

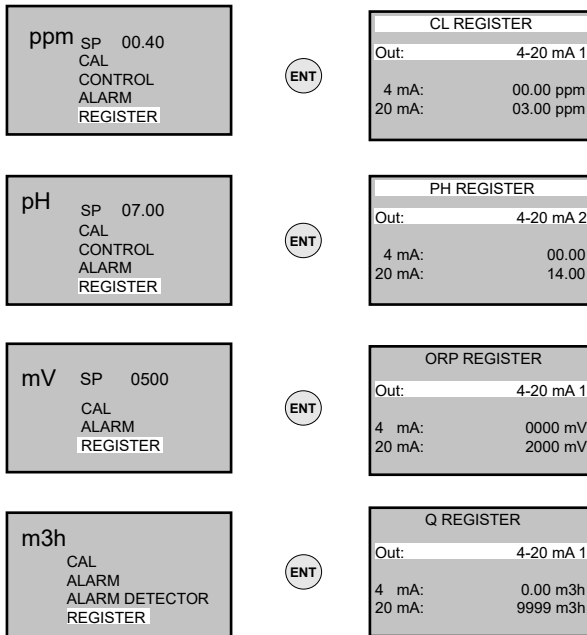

4.7 Configuration and monitor

ppm	0.15	SP	0.40
			032%
pH	7.60	SP	7.00
			021%
mV	500	m3h	10.5
CONFIG			21.3°C

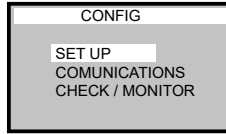

4.7.1 Initial configuration (SET UP)

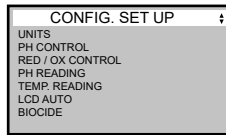
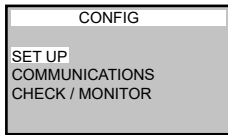

WTRTEC Blue

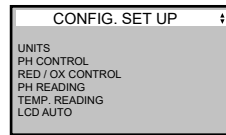

WTRTEC White

- Units:

Enables selection of the working units for the flow rate (litres or gallons) and temperature (Celsius or Fahrenheit)

- pH Control:

To select whether the pH control uses an acid or a base

- Red / Ox Control:

Enables selection of whether the free chlorine control uses an oxidant (such as sodium hypochlorite) or a reducer (e.g. sodium bisulphite)

- pH Reading:

To enable or disable the pH reading, or set the reading manually

- Temp. Reading:

To enable or disable the temperature reading, or fix a value manually

-Flow. T Refresh (only White)

Enabling setting for the refresh time for water flow rate measurement and recalculation of PIQ adjustment

-Flow. Flow Compensation (only White)

When the chlorine sensor is in-line, this enables activation of chlorine reading compensation with flow rate

- LCD auto:

Energy saving option that allowing for switching off of the screen if no action has taken place through the menu in one minute

- Biocide (only Blue):

Allows setting of the chlorine strength in % (usually hypochlorite) used, when PQ control is activated (adjustment of dosing flow rate with inlet of untreated water to the tank)

4.7.2 Communications settings

Setting the communications parameters via the RS485 port. Node, Baud Rate, Parity, and stop bit.

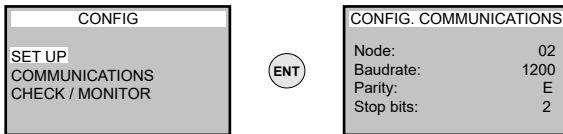

4.7.3 Information on the unit and monitor

This screen displays information on the equipment and the raw value sensor, input and output readings.

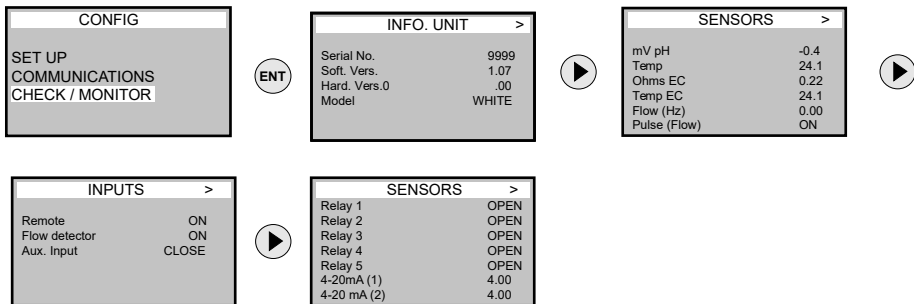

5. INSTALLATION

A place protected from water, away from heat and direct sunlight must be chosen for installation.

5.1. Installation diagram

In-line chlorine control

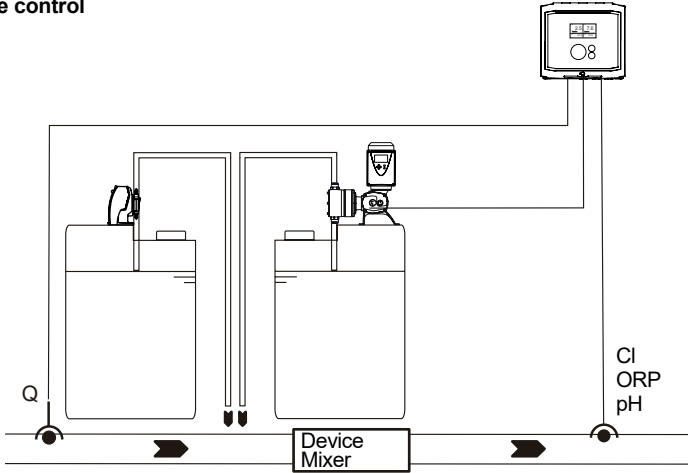

In- tank chlorine control

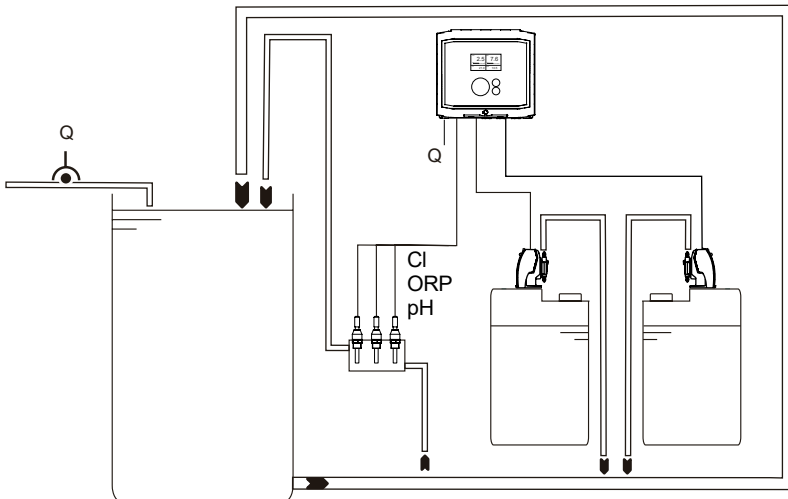

5.2. Wiring

- | | |
|--|---|
| ① 110-240 V _{AC} power supply | ⑪ 4-20 mA output. Output 2. |
| ② 12 V _{DC} power supply | ⑩ Temperature sensor input PT100. |
| ③ Remote ON/OFF input (can be activated with 12-24V _{AC/DC}) | ⑫ Temperature sensor input NTC (ITC EC sensor). |
| ④ pH alarm output. Relay | ⑬ Flow detector input. |
| ⑤ Chlorine alarm output. Relay | ⑭ Input for pH sensor (BNC connector) |
| ⑥ Redox (ORP) alarm output. Relay | ⑮ Input for Cl free chlorine sensor |
| ⑦ Control relay output. Relay 4. | ⑯ Entry for Q flow rate sensor |
| ⑧ Control relay output. Relay 5. | ⑰ Entry for Rx/ORP sensor |
| ⑨ 4-20 mA output. Output 1. | ⑱ Rs-485 |

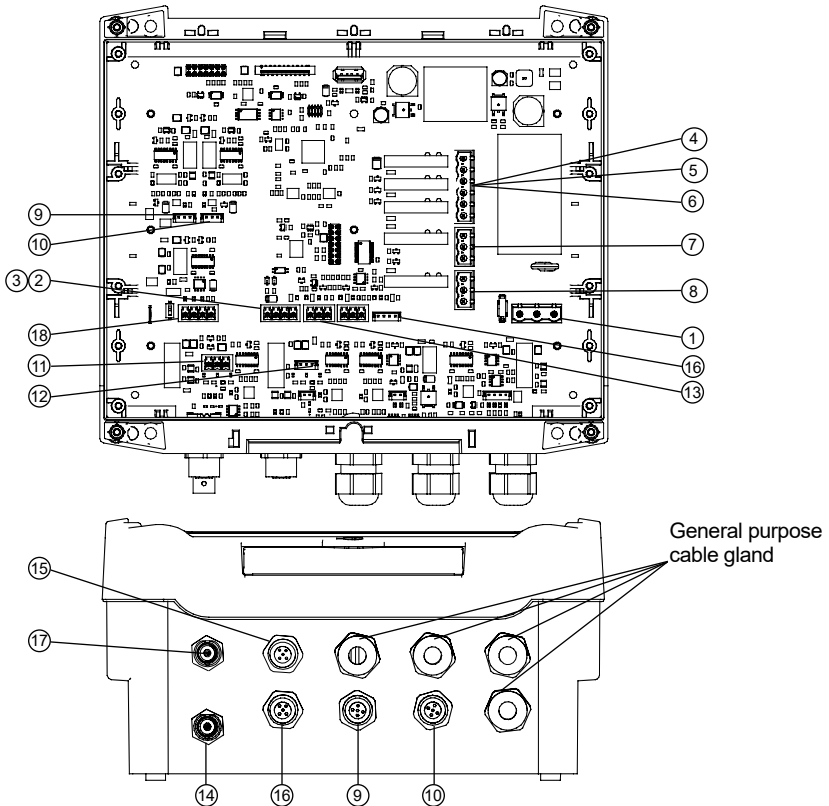

The probe cables must run through separate channelling.

Must be fitted with a power supply circuit-breaking device according to the EN-60204-1 standard.

A device for disconnection in case of emergency must be installed.

The equipment must be protected to prevent abrupt starts

5.3. Remote start/stop activation

100-240 VAC power supply

- External voltage-free signal

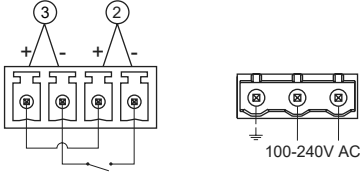

- External 12-24 Vac/Dc signal

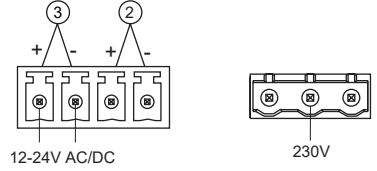

12-24 Vdc power supply

- External voltage-free signal

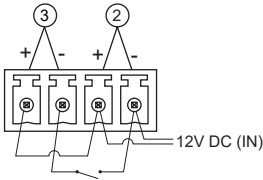

- External 12-24 Vac/Dc signal

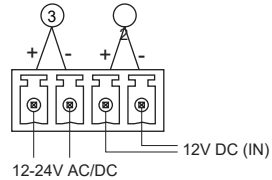

6. START UP AND ADJUSTMENT

1. Installation:

Install the equipment and connect the pumps (see Installing and Wiring)

2. Equipment calibration and configuration:

Calibrate the sensors (pH, flow meter, etc.) (see Calibration)

Configure the equipment:

- Setpoint
- Type of control
- Installation and equipment configurations

3. Check readings

Start up the installation and check that the sensor reading are correct

4. Check operation of the dosing pumps:

Use "Manual" activation if available

5. Determine "T delay" (time delay), according to the installation

6. Alarms:

Once proper operation of the installation has been confirmed, configure the alarms

See section 4.5

7. MAINTENANCE

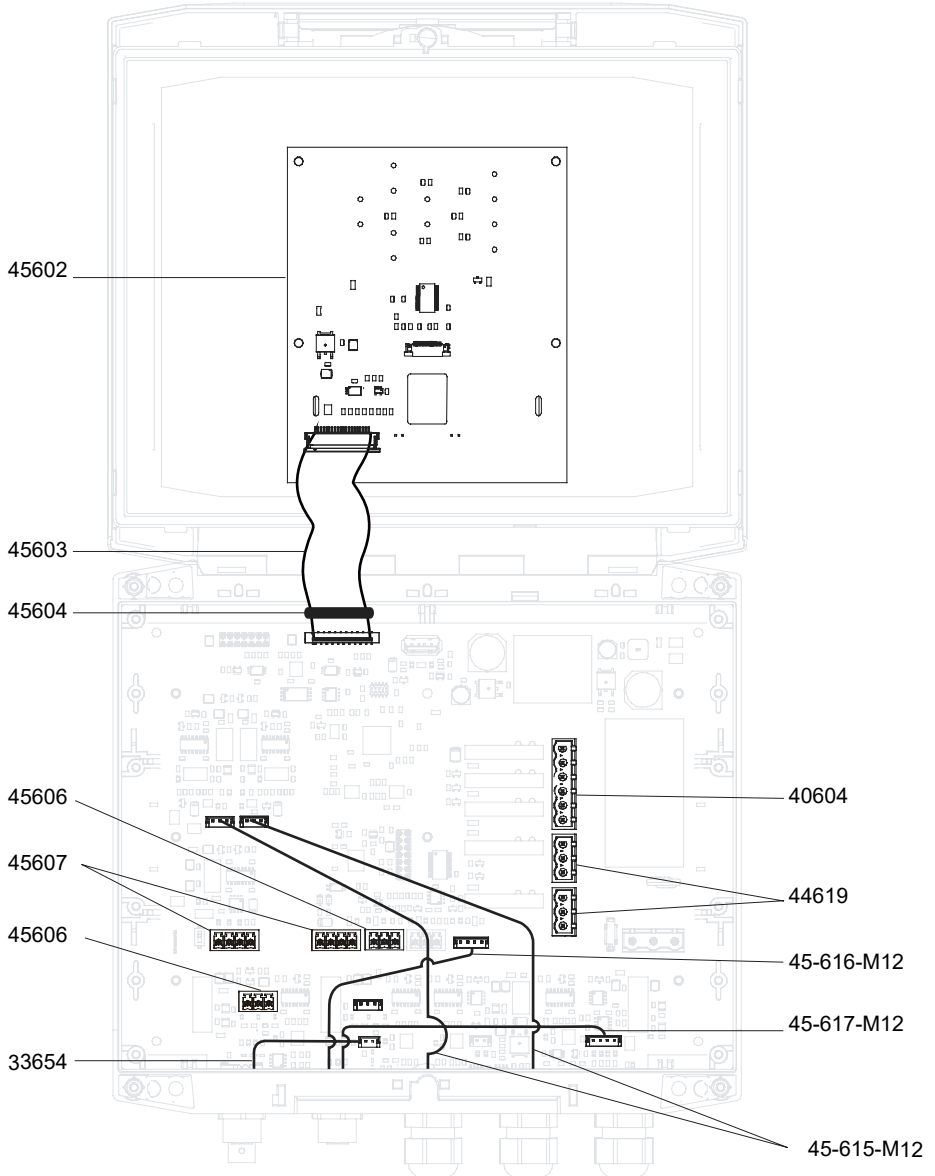

SPARE PARTS

CODE	DESCRIPTION	QUANTITY
33654	Hose cable, 90 mm BNC panel (pH/Rx)	1
40604	Female angled terminal strip, 6 pins RDC06x	1
44604	Female angled terminal strip, 3 pins RDC03x	1
45602	WTRTec display	1
45603	Display cable	1
45604	Ferrite	1
45606	Female angled terminal strip, 3 pins, 3.81 pitch, black	3
45607	Female angled terminal strip, 4 pins, 3.81 pitch, black	2
44619	Female angled terminal strip, 3 pins, 5 pitch	2
40604	Female angled terminal strip, 6 pins, 5 pitch	1
45605	Female angled terminal strip, 3 pins, 7.5 pitch	1
45-615-M12	Hose cable, M12 female panel connector (mA)	2
45-616-M12	Hose cable, M12 female panel connector (flow rate)	1
45-617-M12	Hose cable, M12 female panel connector (chlorine)	1
45622	WTRTEC BLUE electronic board	1
45623	WTRTEC WHITE electronic board	1
ASSEMBLY		
45-601	WTRTEC display board and front panel	1

CE DECLARATION OF CONFORMITY



I.T.C. S.L.
 Vallès, 26
 Polígono Industrial Can Bernades-Subirà
 08130 Santa Perpètua de Mogoda

Declares that the **WTRtec** products identified by serial number and year of manufacture meet the requirements of the Low Voltage Directive 2014/35/EU and the Electromagnetic Compatibility Directive 2014/30/EU, provided that installation, use and maintenance are carried out in accordance with current regulations and according to the instructions in the instruction manual.

Antón Planas
 Manager



I.T.C. S.L. guarantees the product specified in this document, for a period of 1 year from the date of purchase, against all manufacturing or material defects, provided that installation, use and maintenance of the equipment are correct.

The equipment must be sent, free of charge, to our workshop or I.T.C. S.L.-accredited technical service and it will be returned cash on delivery.

The equipment must be accompanied by the warranty document, with the purchase date and stamp of the establishment where purchased, or a photocopy of the purchase invoice.

MODEL

SERIAL No.

Date of purchase and stamp of the establishment where purchased

DATE:

